

2011 Sale Donkey List

Lot # Miniature Donkey

- 1 The Elms Orion^{^^}
- 2 Hill Co Mini's Little La La
- 3 Ass-Pirin Acres Devil May Care
- 4 Heiken's Ark Alisha LB
- 5 The Elms Soft Summer Breeze
- 6 LN Red Dottie
- 7 Assphalt Acres Sadie
- 8 Country Music's Susie Dobbs
- 9 West Prairie Alvere
- 10 KKR Sashay^{***}
- 11 Hill's Haven Tesha
- 12 KZ Prime Mystical Essence
- 13 Arcadian Carol
- 14 Fox Farm's Aleix
- 15 Hill Co Mini's Connie Sue^{^^^}
- 16 The Elms Red Hot Roxie
- 17 Hill Co Mini's Pandora
- 18 Ass-Pirin Acres Japonica
- 19 The Elms Princess Lea^{^^^}
- 20 Assphalt Acres Tyger's Lilly
- 21 West Prairie Leane^{***}
- 22 Sanes Creek Naomi
- 23 LN Flannaglo
- 24 Hill's Haven Savannah^{***}

Lot # Miniature Donkey

- 25 Hill's Haven Zeva
- 26 Heiken's Ark Aggie LB
- 27 Ass-Pirin Acres Justa Joy
- 28 Country Music's Julianne Hough
- 29 KZ Prime Jersey Style
- 30 West Prairie Lana
- 31 Cotton's Bailey^{***}
- 32 The Elms Sugar Baby
- 33 Heavenly Big Ben⁺⁺
- 34 LN China Doll
- 35A The Elms Dynamo ^{^^}
- 35B The Elms Miro^{^^}
- 36 Ass-Pirin Acres Sweet Georgia
- 37 Assphalt Acres Junko
- 38 Hill's Haven Della
- 39 Heiken's Ark Sachi C
- 40 Arcadian Ellen
- 41 Hill Co Mini's Blessing
- 42 Country Music's Sarah Darling
- 43 West Prairie Angel
- 44 Heiken's Ark Rosabelle P^{^^^}
- 45 Ass-Pirin Acres Licorice
- 46 Ravenwood Natchez^{^^^}
- 47 The Elms Preta

^{^^^} Foal by side

^{***} Bred

^{^^} Jack

⁺⁺ Driving Donkey with Cart & Harness

See WWW.DONKEYS.NET for Pictures

2012 Great American Miniature Donkey Sale
 Sale Day – Saturday, July 28, 2012

Now is the time to select those special donkeys you will want to represent your farm breeding program in the 2012 Sale. Sale planning begins in December, deadline early March. Contact us anytime to discuss potential entries and details.

The Great American Miniature Donkey Sale LLC, copyright 2011



Saturday July 30, 2011
Historic Lebanon, Ohio - Fairgrounds

.....
9th Annual Sale Featuring Select Miniature Donkeys
Offered by Breeders from Across North America

.....
Quality Conformation, Diverse Pedigrees, All Colors,
Jennets - Yearlings, 2 year olds, Mature, Bred and With Foal
Select Jacks & Gelding Driving Team With Cart & Harness

.....
 Visit WWW.DONKEYS.NET for
 Web Catalog with pictures

Sale Sponsors
 The Great American Miniature Donkey Sale LLC
 The Elms Farm - Elms Farm Miniature Donkeys
 Martha & Dowell Howard
 Mason, Ohio
mhoward@eos.net
 513-398-3341

Welcome To
The Great American Miniature Donkey Sale
Historic Lebanon, Ohio
At the Warren County Fairgrounds

June, 2011

Dear Donkey Enthusiast,

We are pleased to invite you to 9th annual Great American Miniature Donkey Sale, a select sale featuring quality registered miniature donkeys. The Sale will take place on Saturday, July 30, 2011 at 12:30 PM, in Building C at the Warren County Fair - grounds, 660 N. Broadway, Lebanon, Ohio 45036. We hope you plan to attend.

The Sale will consist of 47 miniature donkey lots. These miniature donkeys have been selected from those offered for consideration. Top breeders are consigning their best, as these donkeys publicly represent their farm and breeding program. It would literally take you many days, and thousands of miles, to view an assortment of available, quality stock like you will see represented at the Sale.

The selected miniature donkeys represent diverse bloodlines, great conformation, and a variety of sizes, colors & ages to attract breeders, show people, and donkey & equine lovers everywhere. Full information on each, including pictures (as consignors make them available), may be found on the web page, www.donkeys.net.

There is something for everyone here, whether you are an experienced breeder, or just getting started. Jennets include; yearlings, coming 2 year olds, mature jennets, bred jennets, and jennets with foals on the side. A trained driving gelding team with a cart & harness is being offered as well as 3 select breeding jacks. Donkey tack and gifts will be available. Whether you are looking for a jennet, a jennet with foal, brood jennets for your breeding program, a herd sire, a driving team ready to go or a loving pet, you are assured of finding only quality miniature donkeys at this sale.

This Donkey Sale is more than just an auction; it is an event, a 'happening'. Donkey enthusiasts everywhere look forward to events such as this and we expect a large turnout from across the Continent. It is an opportunity for folks, both those with years of experience, and those first exploring miniature donkeys, to get together, share experiences, learn from each other, have some fun, make new friends, renew old friendships, and, oh yes, see, bid on, and purchase some of the finest quality miniature donkeys in North America

We hope you plan to attend this year's Great American Miniature Donkey Sale. We are confident you will enjoy it.

Thank You for Your Support

Martha L. Dowell Howard

Absentee Bidding – You must be registered prior to the Sale to phone bid or to bid through another person. Do this early. Please review registration details at www.donkeys.net or call 513-398-3341, 513-225-1771 or 513-919-5613.

Sale Day Telephones: 513-225-1771 and 513-919-5613.

The Great American Miniature Donkey Sale, LLC
Schedule of Events

FRIDAY JULY 29, 2011 SALE SET-UP DAY

Friday is primarily a set-up and check-in day for the Sale. All donkeys must be on site by 4:00 to allow for consignor and vet check-in. There will be limited viewing during the late afternoon. Events are planned as follows:

Viewing Begins	3:00
Consignor's Invitational Dinner	6:00
Measurement	7:00

SATURDAY JULY 30, 2011 SALE DAY

Saturday is the Sale Day. Viewing will begin at 8:00. Breakfast & lunch will be available for purchase. The Donkey Sale starts at 12:30 and checkout begins shortly after the last lot is sold. Donkey tack, gifts, useful items and curios will be available.

Viewing Starts	8:00
Sale Vendors	9:00
Sale Starts	12:30
Payment, Vet Papers	Shortly after last lot is sold
All Donkeys Removed	before 8:00 PM

SALE LOCATION & DIRECTIONS

The Sale will be held at the Warren County Fairgrounds, Bldg C, adjacent to Lebanon Raceway, on Route 48, (660 N. Broadway, Lebanon, OH 45036), 0.7 miles north of the town center of Lebanon, OH. The Lebanon Raceway, a private company, will be in operation, so no parking on paved areas. Parking for the Sale will be marked.

From I-75, take exit #29 (Monroe, Lebanon, Rt 63) east to Lebanon, 7 miles. Turn left on Broadway (Rt 48 North), go 0.7 miles to the Fairground.

From I-71, take exit #28 (Rt 48), turn North, go about 2 miles to Rt 123, exit west toward Lebanon, go 1 mile, turn right on Broadway, go 0.7 miles to the Fairground

Auctioneering & Clerking
Kevin Wendt, Auctioneer
23855 State Route 161
Irwin, OH 43029
419-566-1599
www.thewendtgroup.com
kevin@thewendtgroup.com

The Great American Miniature Donkey Sale LLC

TERMS AND CONDITIONS

Terms: Terms of the sale are cash or good check with photo ID. No credit cards. All donkeys must be paid for immediately at sale end. No donkeys may be removed before payment or Sale close. All donkeys must be removed by 8 PM. (We can help if you want to attend / phone bid, but won't have a trailer at the Sale.)

Bidding: All donkeys sell to the highest bidder. Any disputes or challenges will be settled by the auctioneer, and his decision will be final. The auctioneer may reject any or all bids. Bids are per lot. Jennets with foals on the side sell as one lot.

Risk: Owners assume all risk for their donkey up to the point of sale. Buyers assume all risk at the moment the auctioneer declares the donkey sold. Under Ohio Law, all persons attending the Sale do so at their own risk. The Management, their staff, auctioneers & their staff do not assume responsibility for, and disclaim any liability of any kind for accidents, loss (also animals), and/or personal property damages.

Announcements: Sale day announcements from the auction block take precedence over the material in the catalog or on the web. Every effort has been made to ensure the accuracy of the catalog and web material. However, we assume no liability for errors or omissions from any source.

Contract: The management, auctioneers, and employees act as agents for the seller, but assume no liability for either the buyer or the seller. Any representations made by the sales management are made on behalf of the seller.

The above terms and conditions shall constitute a contract between the buyer and the seller of each animal sold. All guarantees are between buyer and seller.

Health: The EIA/Coggins test will be less than 3 months old. Current health papers for transportation will be good for 7 days past sale date. Proof of pregnancy from a veterinarian is required for bred jennets, otherwise sold as exposed. **Buyers are responsible to obtain the paperwork they need from the veterinarian after payment immediately following the Sale.**

Transport: We may be able to help you get your donkey(s) home. Please let us know if you may need this assistance.

Export: Export buyers will assume all related export costs such as veterinary work, quarantine, shipping, etc. For further clarification, contact us, we export frequently.

General: Please note that information in the catalog has been provided by the consignors. Height data may be birth, immature or adult registered heights and are included only as helpful data. All donkeys will be measured in public view on Friday at the time shown on the schedule. We encourage you to personally inspect the donkeys you are interested in and / or talk with or contact the consignors.

Absentee / Phone Bids

Please contact Dowell or Martha Howard at 513-398-3341, 513-225-1771, or 513-919-5613, or email at mhoward@eos.net by the Wednesday before the Sale

Please Bring This Catalog – Supplies Are Limited

The Great American Miniature Donkey Sale LLC

Camping & Lodging

Camping: Camping available at the Fairgrounds for \$20. Water & electric hook-ups, dump station, restrooms & **HOT** showers. 250 ft from the Sale. Pay Martha.

Motels & B&B

Motel	Miles from Sale	Address	Phone	Web
Lebanon				
The Golden Lamb	1	27 S Broadway	513-932-5065	goldenlamb.com
Shaker Inn	2	600 Cincinnati Av.	513-932-7575	shakerinnmotel.com
Hatfield Inn B&B	5	2563 Hatfield Rd	513-932-3193	bbonline.com/oh/hatfield/
Mason (I-71, Exit 25 - Rt 741)				
Kirkwood Inn	9	4030 S US Rte 42	513-398-7277	kirkwoodinn.com
Super 8 Motel	9	5589 Kings Mills Rd	513-398-8075	super8.com
Hampton Inn	9	5323 Beach Blvd	513-459-8900	hamptoninn.com
Comfort Suites	9	5457 Kings Center Dr.	513-336-9000	comfordsuites.com
Baymont Inn	9	2793 WaterPark Dr.	513-754-1166	baymontinns.com
Microtel Inn Suites	9	5324 Beach Blvd	513-754-1500	microtelinn.com
Mason (I-71, Exit 19 - Fields Ertel Rd)				
Days Inn	15	9735 Mason Montgomery	513-398-3297	daysinn.com
Red Roof Inn	15	9487 Bardes Rd	513-398-3633	redroof.com
Hyatt Place	15	5070 Natorp Blvd.	513-754-0003	hyattplace.com
La Quinta	15	9918 Escort Drive	513-459-1111	lq.com
Marriott	15	9664 Mason Montgomery	513-459-9800	marriott.com
West Chester (I-75, Exit 19 - West Chester)				
Marriott	17	6189 Mulhauser Rd	513-874-7335	www.marriott.com
West Chester (I-75, Exit 22 - Tylersville Rd)				
Wingate Inn	14	7500 Tylers Place Blvd	513-777-1101	www.wingatehotels.com
Monroe (I-75, Exit 29 - Rt 63)				
Howard Johnson	8	150 New Garver Rd	513-539-9221	www.hojo.com
Comfort Inn	8	120 Senate Dr	513-539-2660	www.comfortinn.com
Hampton Inn	8	40 New Garver Rd	513-539-4400	www.hamptoninn.com

Elms Farm Miniature Donkeys

We strive to produce quality miniature donkeys with excellent conformation, great dispositions and personalities

- * **Correct, drafty donkeys - sorrels, blacks, darks, spots & woolies**
- * **Large sorrel herd, one of the most genetically diverse anywhere.**
- * **Herd Sires - Sorrels, Blacks, Spots, Woolies**
- * **Every foal carries sorrel or black genes or both.**
- * **Breed stock selected from herds across North America**
- * **Each mating planned to strengthen desirable characteristics.**
- * **Foundation Herd Planning – Export Expertise**
- * **'Shipping around the Corner or Around the World'SM**

www.donkeys.net

2011 Consignor List

Arcadian Exotics, Paul and Gertrude Suorsa, 133 Branchton Rd.
Slippery Rock, PA 16057, 724-794-3288, c 724-556-1349,
ggsuorsa@embarqmail.com, www.arcadianexotics.com
Lots 13 & 40

Assphalt Acres, Steve and Jill Crim, 3640 N 775E, Manilla, IN 46150,
765-544-2567, c 317-402-3958, assphaltacres@yahoo.com,
www.assphaltacres.com,
Lots 7, 20 & 37

Ass-pirin Acres, Marshlyn and Michael Reed, 4241 VT Rt. 17W, Addison, VT
05491, 802-759-2665, minidonk@together.net, www.asspirinacres.com,
Lots 3, 18, 27, 36, & 45

Bray n' Pool Miniature Donkey Farm, Lester & Linda Sutherland, 6821
Alber Rd. Saline, MI 48176, 734-834-4597, donk@braynpool.com
www.braynpool.com
Lots 23 & 44

Continental Farm, Wayne and Joan Schuetz, 804 SE 11th St., Washington,
IN 47501, 812-254-0811, c 812-486-6809, continentalfarm@yahoo.com,
www.continentaldonkeys.com
Lots 21

Country Music Miniature Donkeys, Rhetta McAlister, 3817 Chevy
Chase Dr., Houston, TX 77019, 713-623-2111, c 713-825-5608,
countrymusic@minidonk.com, www.minidonk.com
Lots 8, 28, & 42

Elms Farm Miniature Donkeys, Martha and Dowell Howard, 5600 Bethany
Rd., Mason, OH 45040, 513-398-3341, c 513-225-1771, c 513-919-5613,
mhoward@eos.net, www.donkeys.net,
Lots 1, 5, 10, 16, 19, 32, 35A, 35B, & 47

Heiken's Ark, Dick and Kathy Heiken, PO Box 35456, Des Moines, IA 50315,
515-962-0667, c 515-360-5911, heikensark@aol.com, www.heikensark.com
Lots 4, 26 & 39

Hill Country Miniatures, Ed and Angela Preston, 339 E. Town East Blvd.,
Sunnyvale, TX 75182, 972-226-6386, c 817-729-7700,
draughonpreston@aol.com, www.hillcountryminiatures.com,
Lots 2, 17, 24, 31 & 41

2011 Consignor List

Hill's Haven, Bill and Sue Hill, 3305 203rd St., Fort Madison, IA 52627,
319-372-3539, c 319-371-5761 hillshaven@q.com,
www.hillshavendonkeys.com,
Lots 11, 25 & 38

KZ's Ass-Piration Acres, Kim and Don Zellers, 1213 Rt. 23
Wantage, NJ 07461, 973-702-8067, c 973-903-6130,
kim@kzasspirationacres.com, www.kzasspirationacres.com
Lot 12 & 29

Lazy N Ranch, Jon, Mary & Jay Nissen, 1080 Hwy 17, Corwith IA 50430
515-824-3603, nisssens@wmtel.net, www.lnminidonk.com
Lot 6 & 34

Little Bit of Heaven, Jack and Sue Pentland, 6480 W 900 N,
Royal Center, IN 46978, 574-643-9359, Heavenly20@frontier.com
Lots 14 & 33

Old Lawson Farm, Mike Kearney, 1745 W. Lawson Rd.,
Bloomington, IN 47404, 812-219-3107, mikekearney5@hotmail.com,
www.oldlawsonfarm.com
Lot 15 & 46

Sanes Creek Ranch, Gilda Caviness, P.O. Box 823, Rushville, IN 46173
317-514-2810, gcaviness@hughes.net, www.sanescreekranch.com
Lot 22

West Prairie Farm, Gene and Betty Willmann, 5455 West Prairie Dr.,
Belleville, IL 62220-5001, 618-235-0221, c 618-578-9676,
genewillmann@sbcglobal.net, www.westprairiefarm.com.
Lots 9, 30 & 43

Notes

1 The Elms Orion

Dark Brown & White Spotted Wooly Jack, 3/30/10, Reg. #Pending
Consignor: Elms Farm Miniature Donkeys, 30.5" June 2011

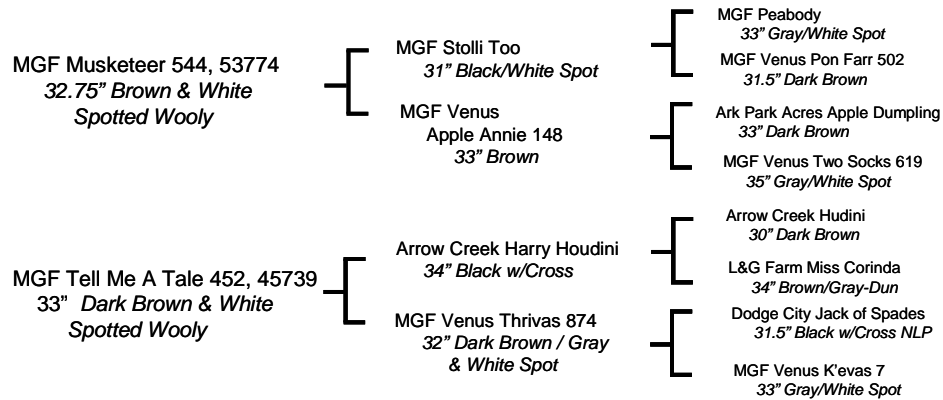

Hair! It's all about the hair! We were seeing stars when Orion was born. This jack is super wooly, with the longest, thickest hair we have seen. It has taken generations of selecting for long hair to get this quality. With good conformation, and a gentle temperament, this is the jack to work for you in a long haired breeding program.

2 Hill Country Miniatures Little La La

Brown Jennet, 9/28/10, Reg. #Pending
Consignor: Hill Country Miniatures, 19" at Birth

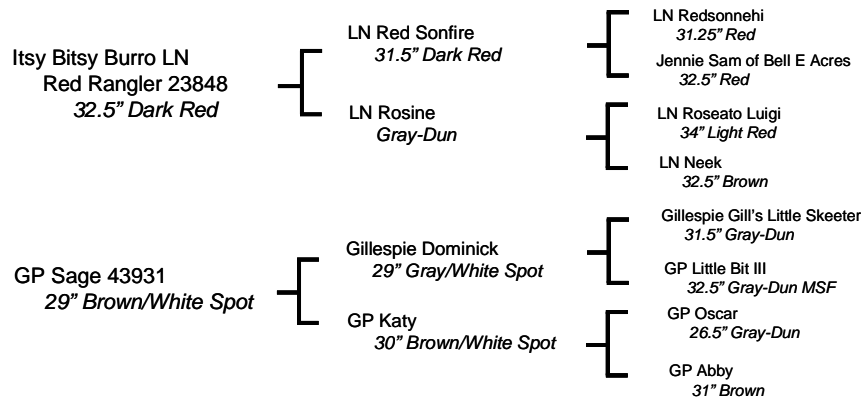

Little La La is a very small, refined, balanced jennet with a tiny head. We expect she will stay small. Her half sister was high seller in 2010. Her dam is a 29", stocky, correct, spotted jennet. Her sire is a dark red, Reserve National Grand Champion, Her pedigree is loaded with notable donkeys, including GP Oscar, 45 Magnum, Red Sonfire, Redsonnehi, and Valintino 50th. Bred right she has a 50% of throwing red. She is show quality all the way.

3 Ass-Pirin Acres Devil May Care

Red Jennet, 7/10/10, Reg. #Pending
Consignor: Ass-Pirin Acres, 19" at Birth

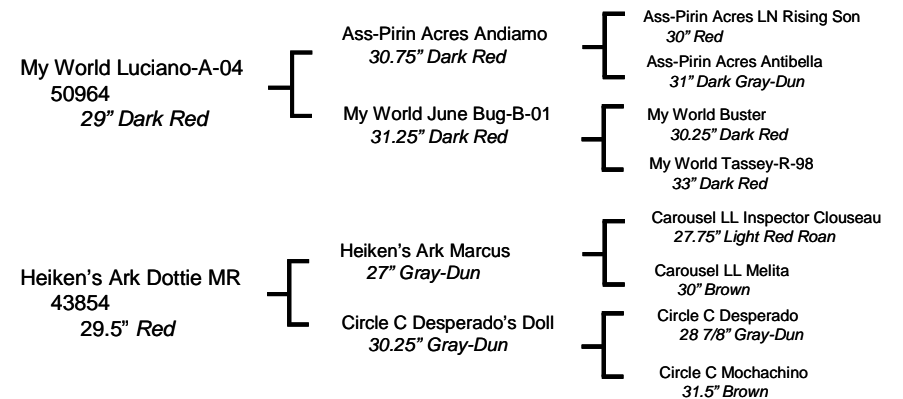

Wow! If you want it all, this is the jennet! She's got the conformation, the short size, the red color, and the proven genetics to be top quality for the best of herds. Her dam was a sale topper at this sale, and her sister 2nd highest.

4 Heiken's Ark Alisha LB

Brown, Gray & White Spotted Jennet, 7/7/09, Reg. #59069
Consignor: Heiken's Ark, 29.25" Aug 31, 2010

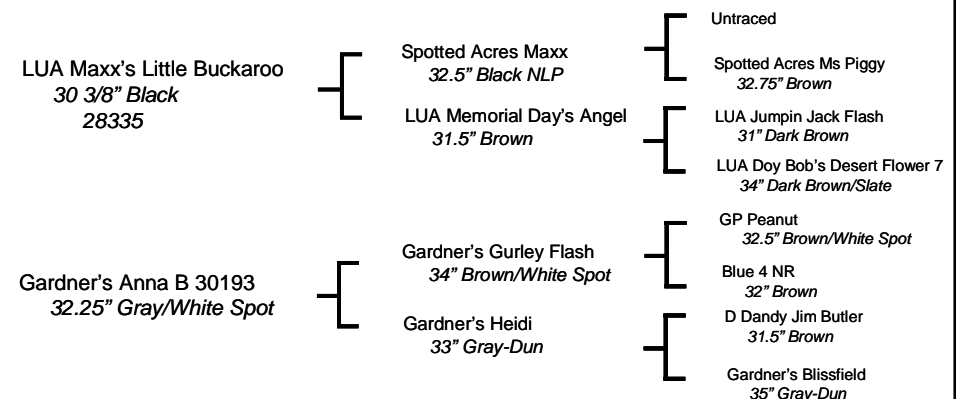

Alisha is a nice spotted jennet by LUA Maxx's Little Buckaroo. This black jack gives nice bone and conformation to his foals. Alisha is no exception. If you want to produce dark spotted donkeys, Alisha should be able to do that with the right jack. Give her a try.

5 The Elms *Soft Summer Breeze*

Red Jennet, 7/1/10, Reg. #60903

Consignor: Elms Farm Miniature Donkeys, 20" at Birth

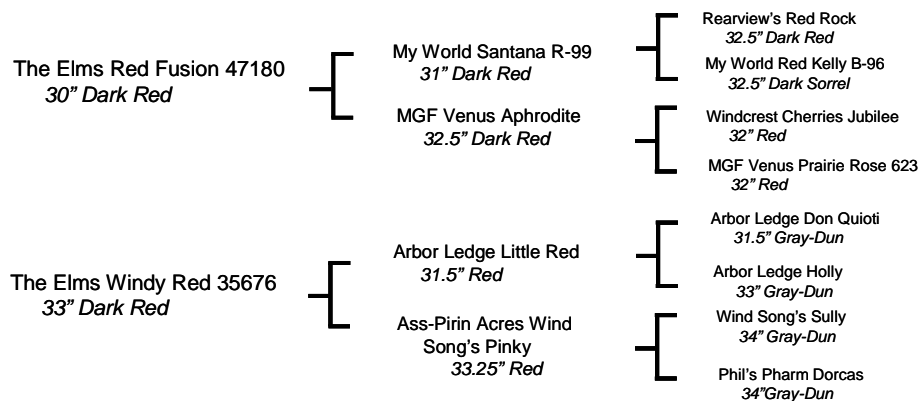

An eye catching jennet with a gorgeous face. Good chest and build, the result of generations of excellent breeding. She is a lovely soft red color, as refreshing as a Soft Summer Breeze....

6 LN *Red Dottie*

Red Jennet, 7/9/10, Reg. #Pending

Consignor: Nissen's Lazy N Ranch, 21.75" at Birth

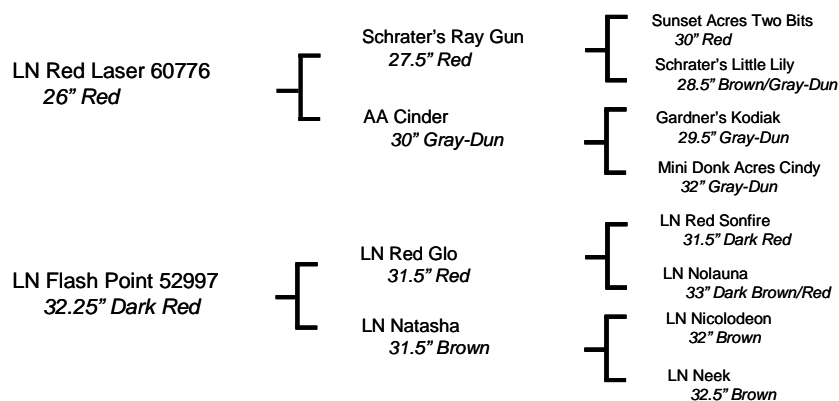

Red Laser paired with our jennets has produced unsurpassed quality and balance, super red color and exquisitely refined heads. Combined with her great pedigree, a fine jennet such as Red Dottie will stand out anywhere in the world.

7 Assphalt Acres *Sadie*

Red Jennet, 5/31/09, Reg. # Pending

Consignor: Assphalt Acres, 31" @ 22 months

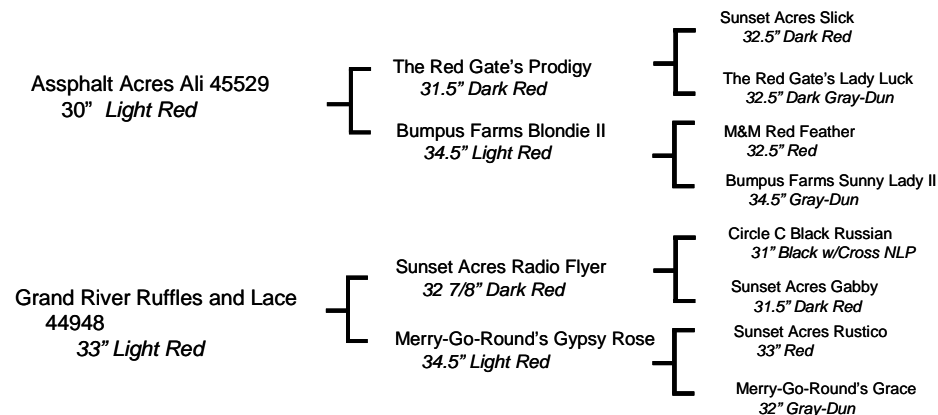

Take a look at this little 2 year old red jennet. She's is a medium red, and a mirror image of her sire, Ali. Sadie, like her sire, is small, compact, and as straight and wide as they come. Sadie also has Ali's willingness to please. Sadie will be a great addition to any herd.

8 Country Music's *Susie Dobbs*

Dark Brown Jennet, 3/18/09, Reg. #58627

Consignor: Country Music Miniature Donkeys, 21" at Birth

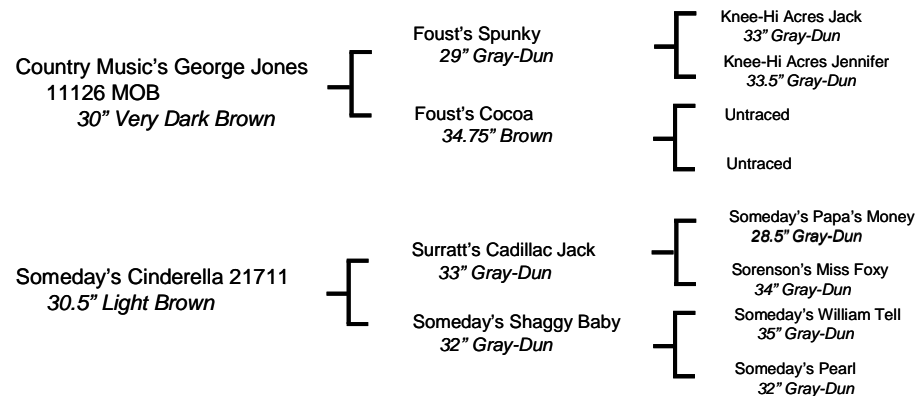

Susie's an eye catching, beautiful jennet. She was the highest placing jennet in the yearling class for jacks and jennets at the 2010 Houston Livestock Show. Her dam's full, deep pedigree represents the breeding program of a well respected Texas breeder, Arnold Sorenson. Her sire, George Jones, has produced National Champions at Halter and Driving in the US, Canada, Europe & New Zealand.

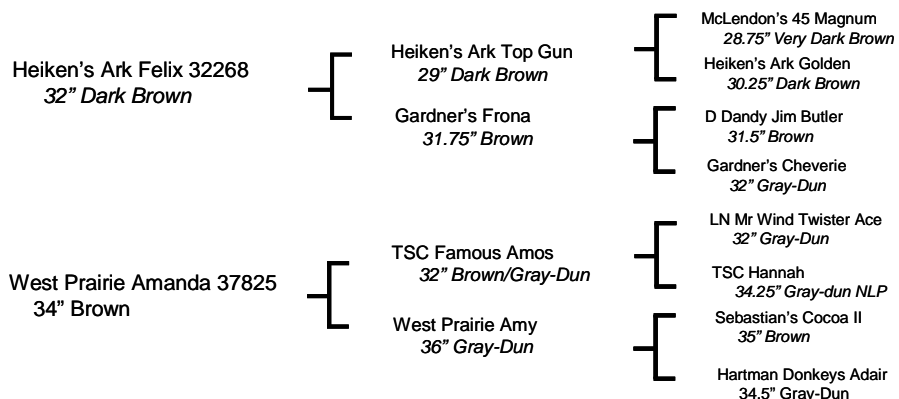
9 West Prairie *Alvere***Brown Jennet, 6/3/09, Reg. #Pending****Consignor: West Prairie Farm, 30" March 2011**

Alvere is a nice small, 2 year old who looks great head to toe. We expect her to stay small. She's gentle and likes attention. She has nice pedigree on both sides. She will make a great addition to most herds. Stop, look and take her home!

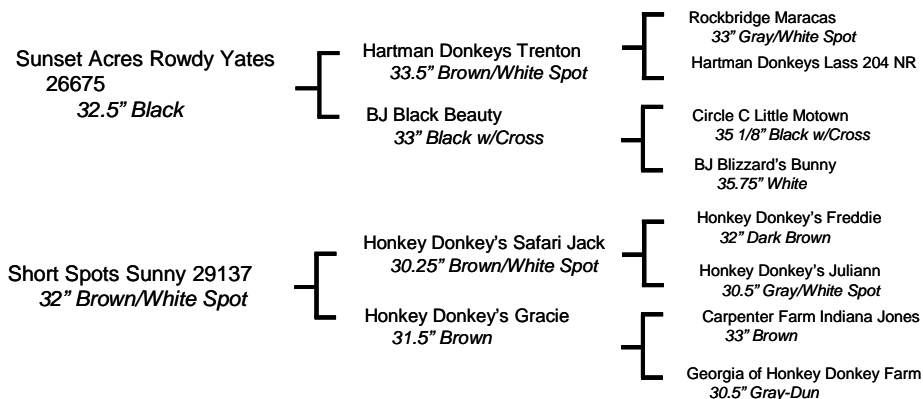
10 KKR *Sashay***Dark Brown & White Spotted Jennet, 4/30/04, Reg. #39785****Consignor: Elms Farm Miniature Donkeys, 33", Bred for 2012**

Meet Sashay, a beautiful spotted jennet bred for 2012 to The Elms Dynamo, a coal black son of The Elms Rembrandt. Sashay is the dam of 3 exceptionally well built foals. She is the half sister of several NMDA show winners, coming from the well known KKR show program. With the spot pattern everyone loves, and her excellent conformation, she is the jennet to produce the showy spotted foals you like.

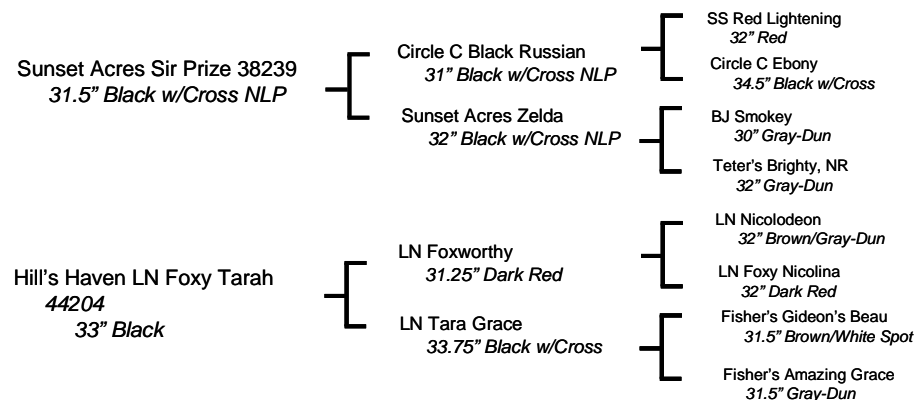
11 Hill's Haven *Tesha***Black w/Cross Jennet, 5/24/10, Reg. #59505****Consignor: Hill's Haven, 27.5" March 2011**

Hill's Haven Tesha is small with great conformation. Her sire has produced many top grade foals. He goes back to Circle C Black Russian and Sunset Acres Zelda. Her dam, Foxy Tarah goes back to LN Foxworthy. She has a nice full pedigree with heavy doses of both red and black. She's a great choice for either a red or black / dark program.

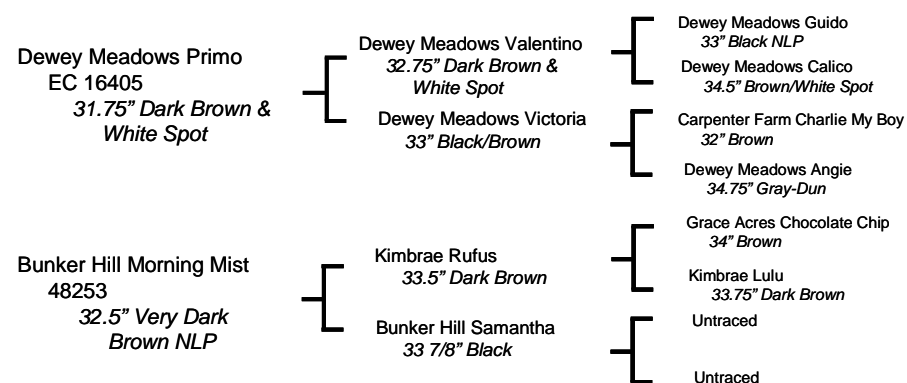
12 KZ *Prime Mystical Essence***Black and White Spotted Jennet, 8/8/10, Reg. #Pending****Consignor: KZ's Ass-Piration Acres, 21" at birth**

Essence is what our goal for breeding is all about! Small, nice conformation, a compact body in a spot, and to top it off, black & white in color. Essence is also a full sister to KZ Radiance In The Mist, who sold at the 2008 Great American Sale. This Primo daughter is sure to be an asset to your breeding program.

13 Arcadian *Carol*

Red/Brown Jennet, 3/27/09, Reg. #Pending
 Consignor: Arcadian Exotics, 31.5" March 2011

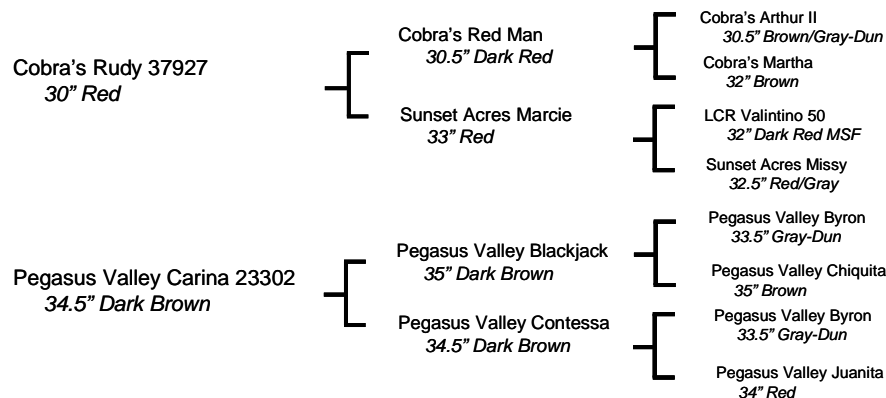

Carol is a personable, small, 2 year old red-brown jenny. Her sire, Cobra's Rudy, a 30" red, comes from a desirable pedigree mix of the Cobra line and Sunset Acres & LCR donkeys, including Valintino 50th. Her dam's, complete Pegasus Valley line fills out this full pedigree. Bred to red jack when mature, there should be a 50% chance of producing red.

14 Fox Farm's *Aleix*

Black NLP Jennet, 7/30/09, Reg. #58698
 Consignor: Little Bit of Heaven, 32" March 2011

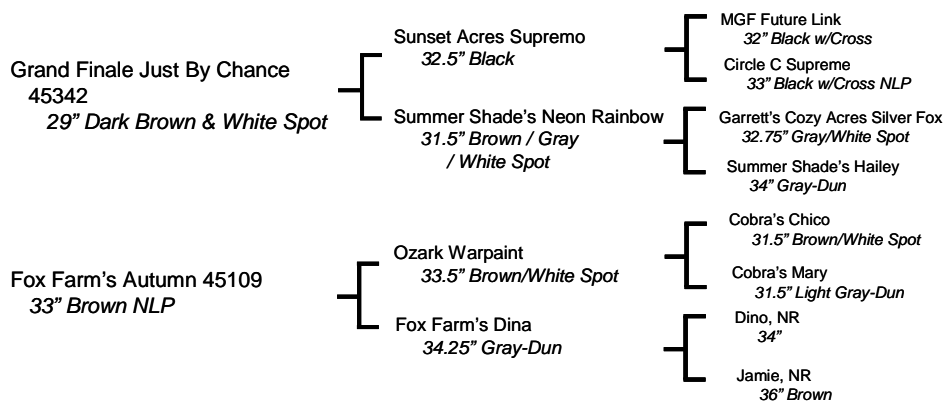

Aleix is a nice, black NLP jennet, with a heavy dose of nice spot ancestors on both her sire's and dam's sides. Her pedigree sports MGF, Cobra, Sunset Acres and Circle C lines, all well known breeders of fine donkeys. Aleix, paired with a spot jack when mature, should give you a good chance for a spotted foal. Don't pass up on an opportunity like this.

15 Hill Country Mini's *Connie Sue*

Brown Jennet, 2/16/07, 33.5" Reg. #48921,
 Old Lawson *Houdini*
 Dark Brown Jack Foal, 5/10/11, 22" at Birth, Reg. #Pending
 Consignor: Old Lawson Farm

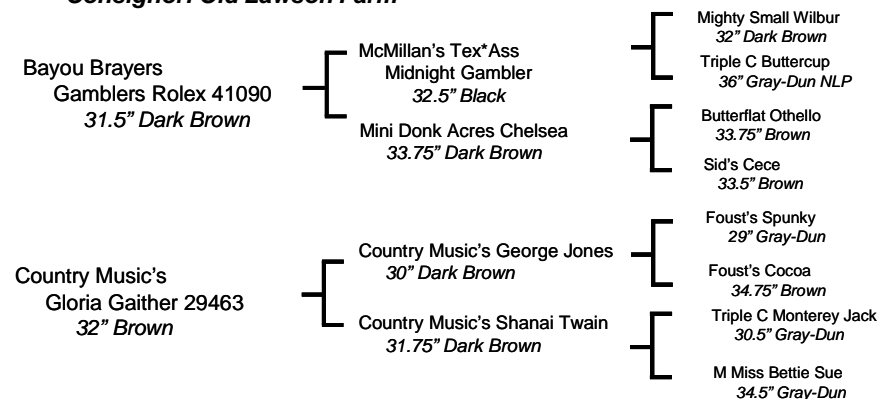

Connie Sue is a 4 year old jennet with that desirable "George Jones head". She has great conformation with straight legs and is one of only two Rolex daughters in the US. Her foal at side, Houdini, was sired by Hill Country Miniatures Liberty, a coal black jack that was the 2003 Texas State Champion.

16 The Elms *Red Hot Roxie*

Very Dark Red Jennet, 6/1/10, Reg. #60132
 Consignor: Elms Farm Miniature Donkeys, 21" at Birth

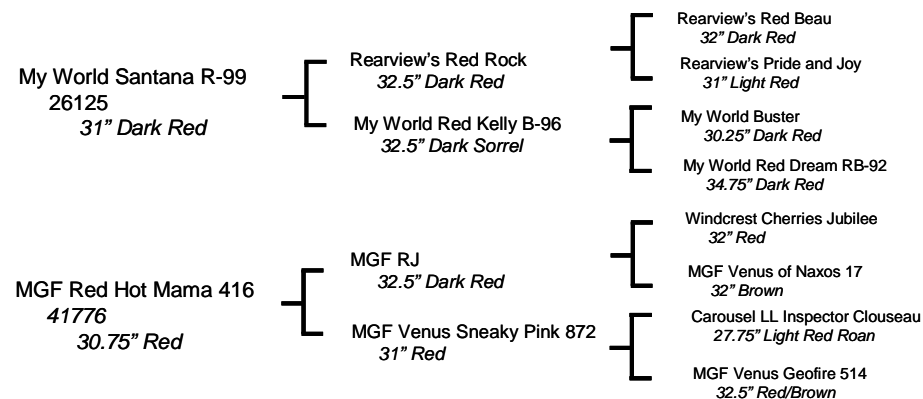

Roxie is Red Hot Red! Stunning jennet, great build, and tons of eye appeal! Ooh la la! Absolutely fabulous, desirable red pedigree on both sides. Put Roxie in a green pasture, and you have a Christmas package to delight you all year long.

17 Hill Country Miniatures *Pandora*

Dark Red Jennet, 8/9/10, Reg. #Pending

Consignor: Hill Country Miniatures, 28" March 2011

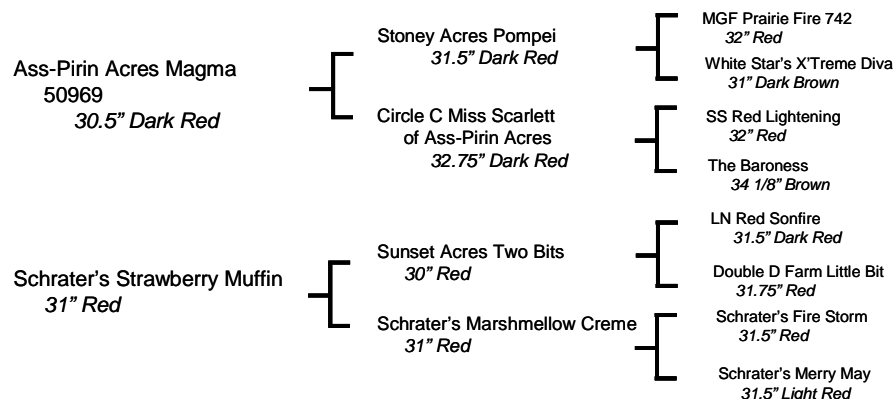

Pandora is a very dark red show jennet. Her sire and dam were both multiple NMDA Grand Champions. Her Dam was also 'Best of Breed' at the 2007 Texas State Championship and the 2007 Great Celebration in Tennessee. Pandora is fulfilling her destiny, placing first in yearling class at the 2010 Houston Livestock Show when only 6 months old. Her new owner will also get to proudly wear the gorgeous 'Gist' buckle that she won for them.

18 Ass-Pirin Acres *Japonica*

Red Jennet, 5/26/10, Reg. #Pending

Consignor: Ass-Pirin Acres, 28" March 2011

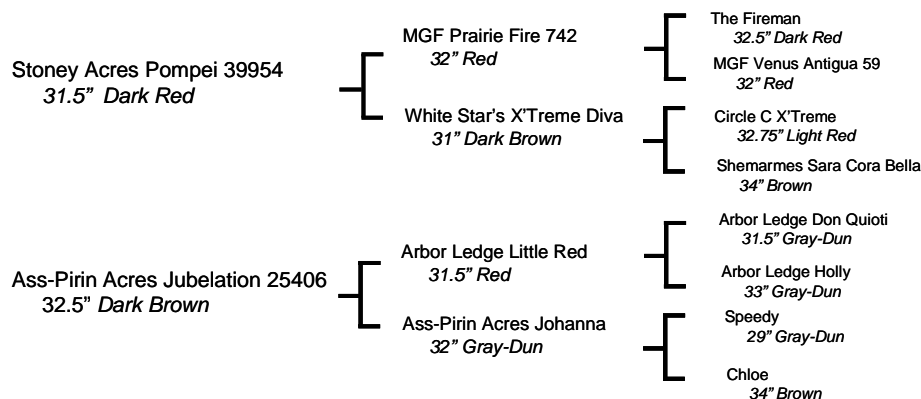

What can I say about this one? Everything Good - - size, color, pedigree! Look at me attitude! Special!

19 The Elms *Princess Lea*

Very Dark Brown Jennet, 9/22/06, 31 1/8" Reg. #54402, Bred for 2012

The Elms *Princeton*

Dark Brown Jack Foal, 5/17/11, 21.25" at Birth, Reg. #Pending

Consignor: Elms Farm Miniature Donkeys

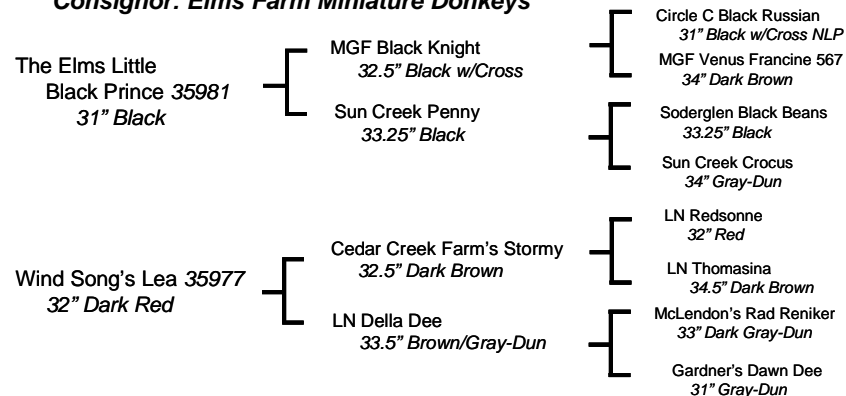

Princess is a small, stocky jennet, and has had two foals. One is a very nice 50 / 50 spot, the other a chocolate. Her dam is an exceptionally well built, intense dark red with flashy white legs and points, so we bred Princess to our 29.5" red jack, The Elms Mr. Independence, to try for a rich red 2012 foal. This jennet can throw lots of color, and next year should be red! Check out this 3 in 1 package.

20 Assphalt Acres *Tyger's Lilly*

Dark Brown & White Spotted Jennet, 5/9/10, Reg. #60339

Consignor: Assphalt Acres, 29" at 10 Months

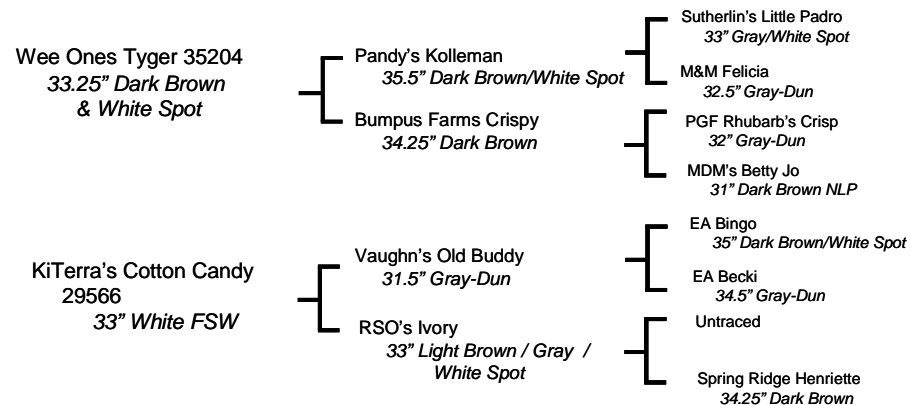

We can't keep them all or we would definitely keep this jennet. Tyger's Lilly is the daughter of 3 time ACOSA National Champion Wee One's Tyger. Not only is she a very flashy girl, but she has that 'Look at me' attitude that you want in the show ring. Bring your trailer because you will want to take this girl home with you.

21 West Prairie *Leane*

Brown Jennet, 8/18/01, Reg. #37827

Consignor: Continental Farm, 31 3/8", Bred for Fall 2011

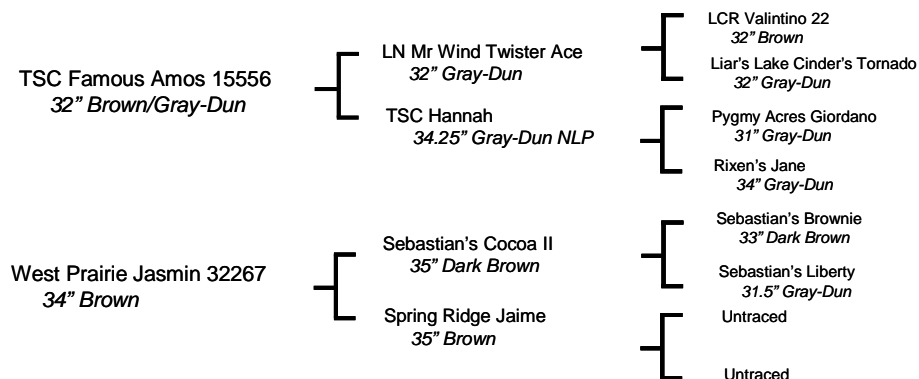

Leane is a nice small brown jenny with dark cross, good conformation, very gentle. She is a proven jennet and has been a great jennet for us, having had jennet foals each time. She is bred for this fall 2011 to our Herd Sire, MGF Jock. Jock is the sire of Hill Country Prada, the high selling jennet at this sale last year. Think what you will get this fall!

22 Sanes Creek *Naomi*

Very Dark Brown Jennet, 9/5/09, Reg. #58537

Consignor: Sanes Creek Ranch, 21.5" at Birth

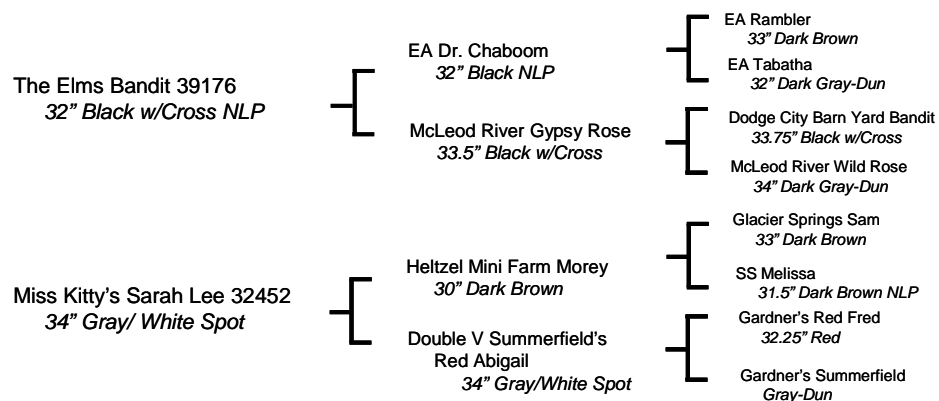

Naomi is a nice looking, well built little jennet with unusual desirable genetics. Her sire, The Elms Bandit, comes from the unique black line of Dr. Chaboom crossed with the nice, but limited Canadian McLeod River line. Her dam, Miss Kitty, adds spots and a full pedigree as well. Naomi should make a great addition to your breeding program, adding some nice color possibilities.

23 LN *Flannaglo*

Dark Red Jennet, 4/11/06, Reg. #47967

Consignor: Bray'n Pool Miniature Donkey Farm, 31.5"

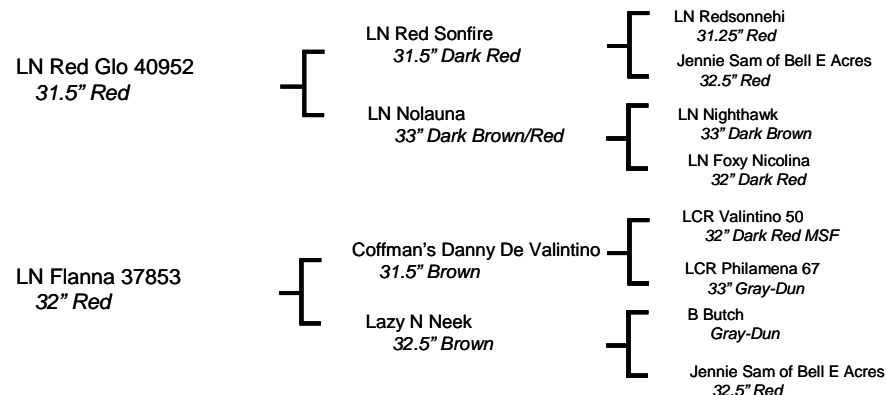

A great little jenny with lots of red color in her pedigree. Bloodlines back to the imports. She's super friendly and her first foal was a real looker with a sweet heart personality. We know how important it is to have personality in breeding jennies, and this girl will steal your heart. Flannaglo is ready for a long breeding career. Open and ready to breed with your best jack.

24 Hill's Haven *Savannah*

Dark Red Jennet, 4/7/07, Reg. #52232

Consignor: Hill Country Miniatures, 31.75", Bred for 2012

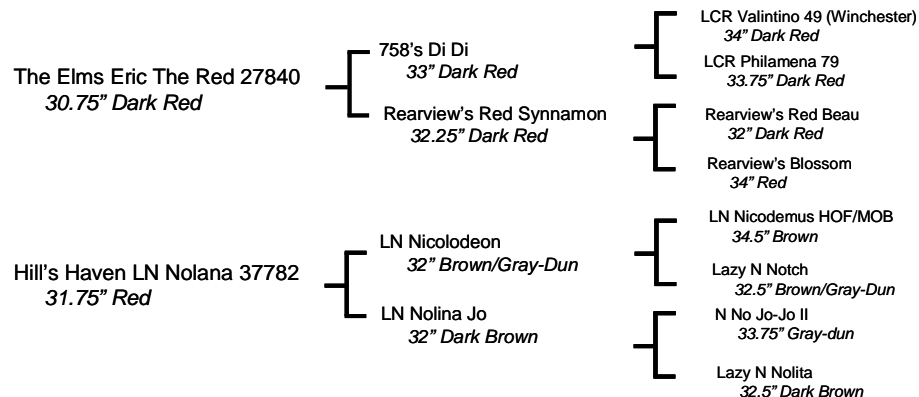

Savannah is a very dark, correct 4 year old 31.75" sorrel jennet with a deep hip, superb leg set and great top line. She was pasture bred to World Champion Circle C Obsession (32.5") from Nov 2010 to July 2011. Her pedigree is loaded with reds; The Elms Eric the Red, Valentino 49 and 50, & Rearview's Red Synnamon. Pair that with Obsession's pedigree including Red Lightning, Circle C Coco Chanel and Motown and you are almost guaranteed a knockout foal.

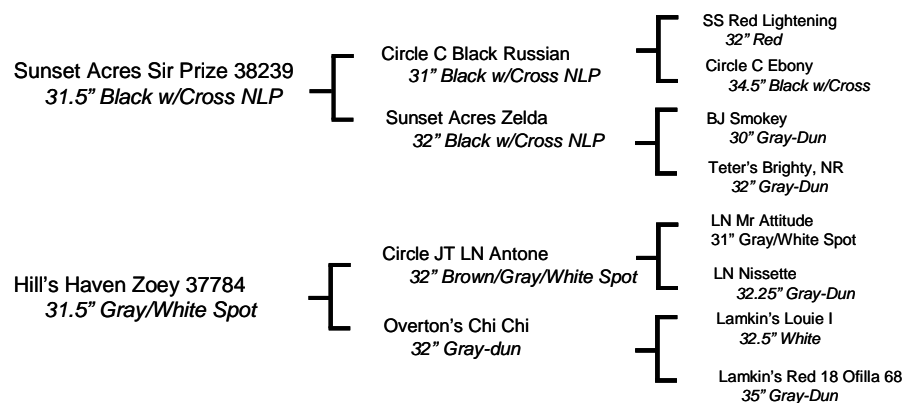
25 Hill's Haven Zeva**Brown, Gray & White Spotted Jennet, 5/22/10, Reg. #59504****Consignor: Hill's Haven, 22" at Birth**

Zeva's a nice spotted jennet that will be well over a year old at Sale time. Her pedigree is filled with blacks and spots and includes a variety of well known genetic lines. Sir Prize has sired a lot of very nice foals for us and Zeva is no exception. She will make a nice addition to anyone's breeding program.

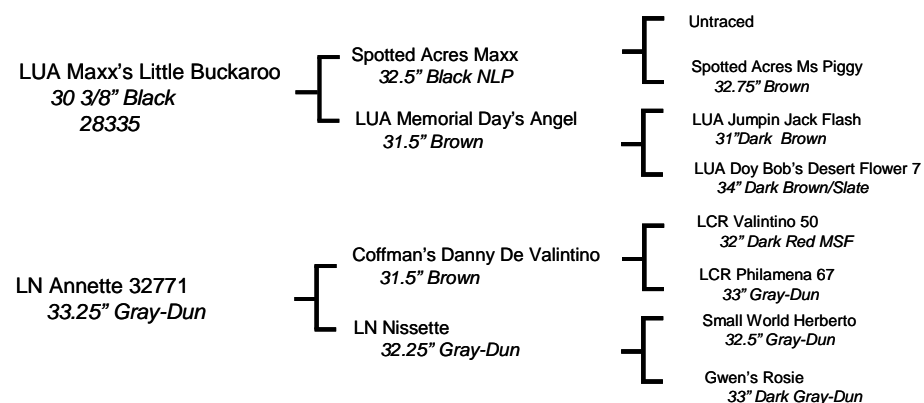
26 Heiken's Ark Aggie LB**Very Dark Brown Jennet, 7/28/09, Reg. #59070****Consignor: Heiken's Ark, 29.5" Sept 2010**

Aggie has the color, conformation, and size to be a great asset to most herds. If we kept her, we would probably breed her to a spotted jack and try for a black and white spotted foal. She has a very nice pedigree and great potential. Don't pass her up.

27 Ass-Pirin Acres Justa Joy**Brown Jennet, 6/19/10, Reg. #Pending****Consignor: Ass-Pirin Acres, 26.5" March 2011**

We really like this little jenny. She is short, wide and correct. Forget the color – look at the conformation and size. Justa Joy will enhance any herd.

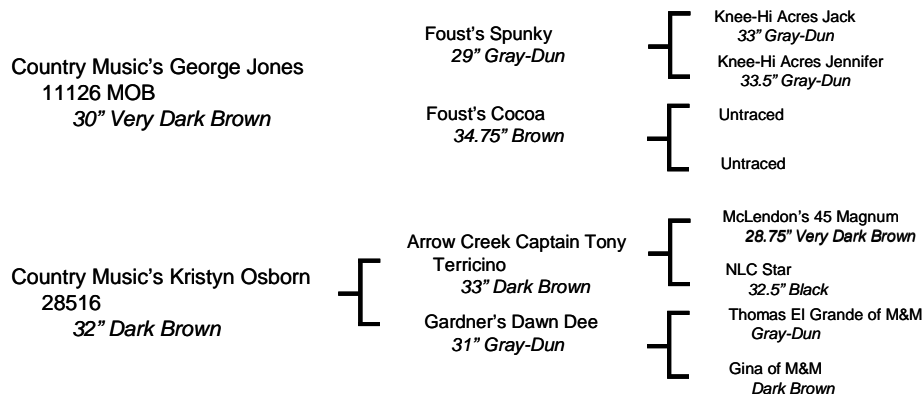
28 Country Music's Julianne Hough**Dark Brown Jennet, 10/6/09, Reg. #58632****Consignor: Country Music Miniature Donkeys, 29.75" March 2011**

Julianne Hough is small, dark, stocky & strong boned. Wonderful mannerly temperament, very well trained, ready to show at halter and lead line obstacle. Her dam has a strong 4 generation pedigree dating back to an early import, Luigi from Sardinia. Her sire and grandsire are both National Champions at Halter. George Jones has sired over 25 National Champions at Halter and Driving in the US, Canada, Europe & New Zealand.

29 **KZ Prime Jersey Style**

Dark Brown and White Spotted Jennet, 7/21/10, Reg. #Pending
Consignor: KZ's Ass-Piration Acres, 22" at birth

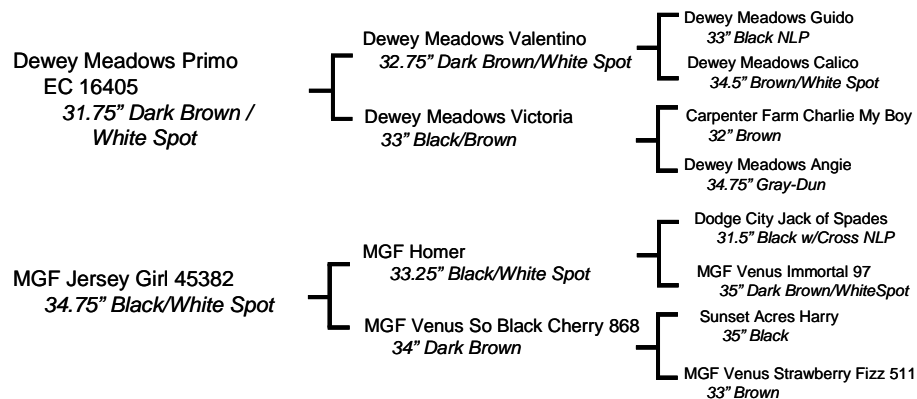

Jersey Style is just that, Style!! A flashy product of two black and white parents, Style should continue to get darker with age and be a black and white herself. Tons of pedigree with many dark spotted and well known names in it. Shouldn't everyone have a little Style in their herd?

30 **West Prairie Lana**

Gray-Dun Jennet, 6/30/09, Reg. #Pending
Consignor: West Prairie Farm, 32.5" March 2011

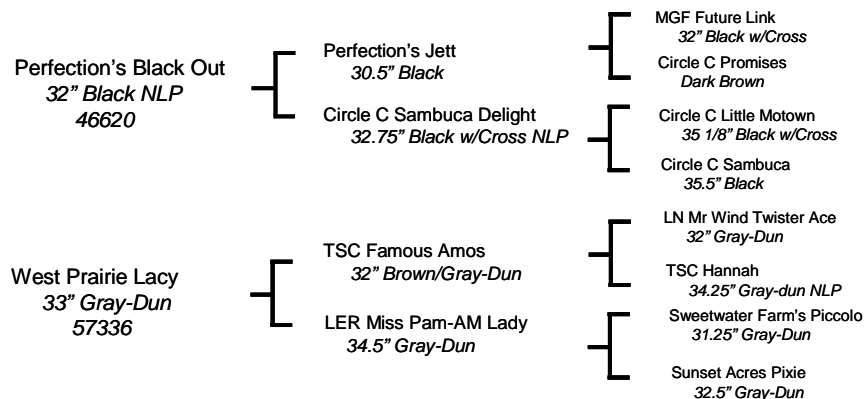

Lana is a nice 2 year old gray-dun with a black cross and black ear tips. She should produce black, dark or gray offspring, depending on the jack's color. She has a long pedigree on both sides with some well known donkeys. She will make a great dam in most herds. Take a good look at this beautiful, and gentle jenny.

31 **Cotton's Bailey**

Black Jennet, 5/12/08, Reg. #53324
Consignor: Hill Country Miniatures, 32" March 2011, Bred for 2012

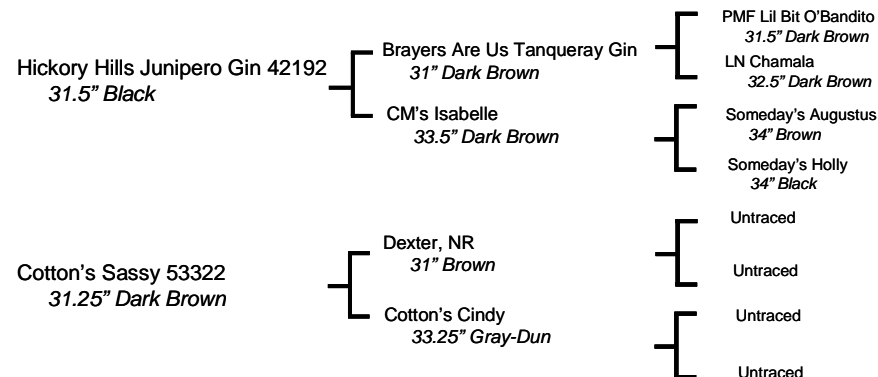

Bailey is a small ink black jennet with a large white star and white belly. She is very refined, has great movement, a small head, and a perfect topline. She is bred to HHAA Sweet Spotz, a true black and white spotted jack (HA Napoleon X Sunset Acres Sweet Pea) for spring 2012 foal. Sweet Spotz is the 2011 NMDA National Champion Spotted Jack, is wildly spotted, and has the rare blue-black color.

32 **The Elms Sugar Baby**

Red & White Spotted FSW Jennet, 8/1/10, Reg. #60902
Consignor: Elms Farm Miniature Donkeys, 21" at Birth

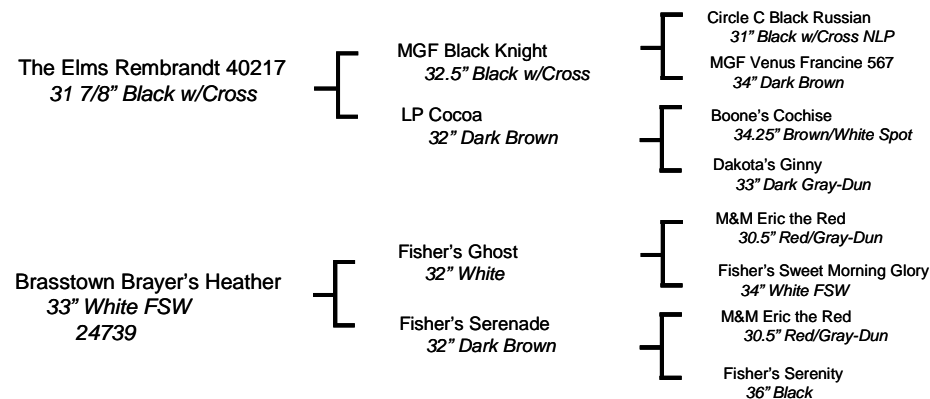

White is reserved for royalty, and you can see why. This splendid white jennet really lights up the field. She is red based spotted, so can produce a wide range of colors in spotted or solid. Sweet like Sugar, she's your Baby!

33 Heavenly Big Ben

Gray-Dun Gelding, 6 yrs,
Driving Gelding with Cart and Harness
Consignor: Little Bit of Heaven, 35"

Untraced Sire

Untraced Dam

Big Ben is a well trained 6 year old Gelding. He's a very nice driver and anyone can handle him. Ben sells as a complete outfit including an easy entry cart and Amish made harness. Jack Pentland, the consignor, is the trainer and has been training driving donkeys for years. He can answer any questions you might have. Well trained driving geldings are difficult to find, so here's your chance. Buy him today, enjoy driving as soon as you get back to your place.

34 LN China Doll

Brown and White Spotted Jennet, 8/23/10, Reg. #Pending
Consignor: Lazy N Ranch, 22" at Birth

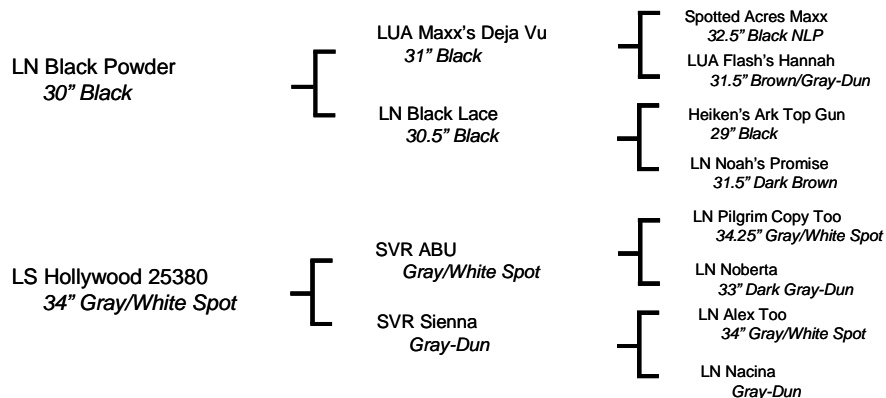

This gal is a fancy, stout built daughter of 2 exceptional parents. She is at least a brown and white spot like her maternal half sister Patchwork. Although Patchwork carries slightly fewer black genes, she has produced black and white spots. China Doll is a good prospect to get quality spots with rich color into your herd.

35A The Elms Dynamo

Lot 35 Sells As Choice

Black Jack, 4/22/09, Reg. #Pending
Consignor: Elms Farm Miniature Donkeys, 31.5" May 2011

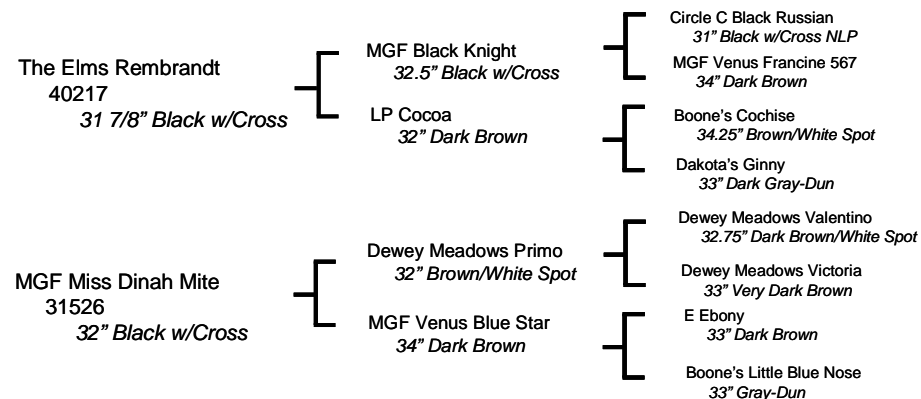

A dynamic jack, a true black with a flashy white belly. Wide chest, good bone, pretty head, a pedigree he's proud of, and the great temperament that his sire and grandsire are known for. Dynamo's a fine breeding prospect who has already started his career at Elms Farm.

35B The Elms Miro

Lot 35 Sells As Choice

Dark Brown & White Spotted Jack, 6/17/09, Reg. #Pending
Consignor: Elms Farm Miniature Donkeys, 31.5" April 2011

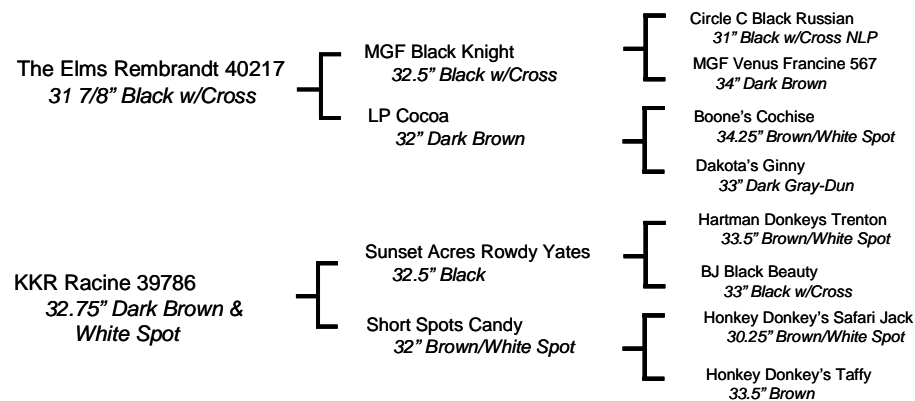

Miro is a well built spotted jack, with a rounded hip, and the great temperament his sire throws. His dam is from the KKR show program and half sister to several NMDA show winners. Miro's pedigree is ideal for a spotted herd sire with really nice well built spots & blacks on both side. Take him home and add sparkle to your spotted program.

36 **Ass-Pirin Acres *Sweet Georgia***
 Dark Brown Jennet, 9/4/10, Reg. #Pending
 Consignor: Ass-Pirin Acres, 21" at Birth

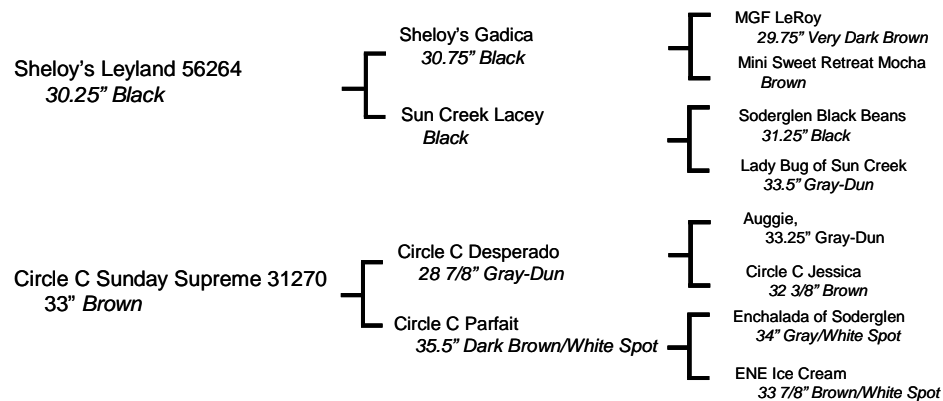

Sweet, Sweet! Not only sweet, but correct in every way. Some good old genetic lines. The famous Circle C Desperado is her grandsire, and it shows in this girl.

37 **Assphalt Acres *Junko***
 Gray-Dun Jennet, 8/19/09, Reg. #60189
 Consignor: Assphalt Acres, 31.5" June 2011

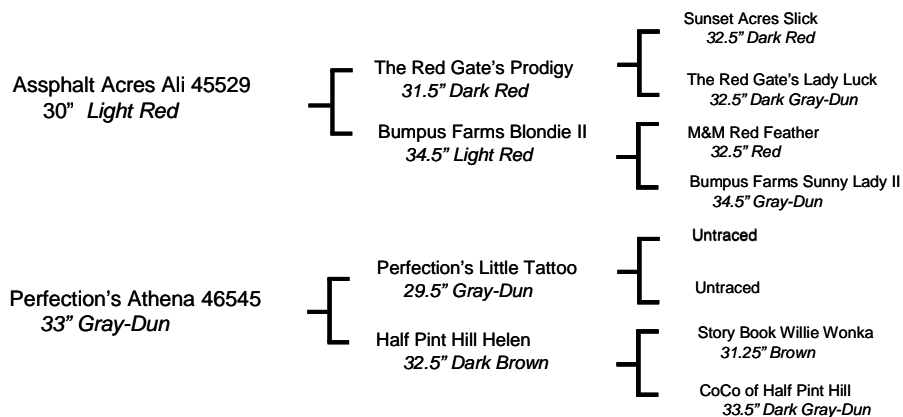

Original! This girl was born early in the morning the day the Japanese Delegation visited ASSphalt Acres. We asked the girls to help us name the baby. Junko is close to Jenny in Japanese, so that's it. It is pronounced June-Ko. Back to the basics with this one. Perfect conformation, beautiful garters on her legs and that classic gray. What a combination!!

38 **Hill's Haven *Della***
 Dark Red Jennet, 7/29/10, Reg. #60129
 Consignor: Hill's Haven, 22" at Birth

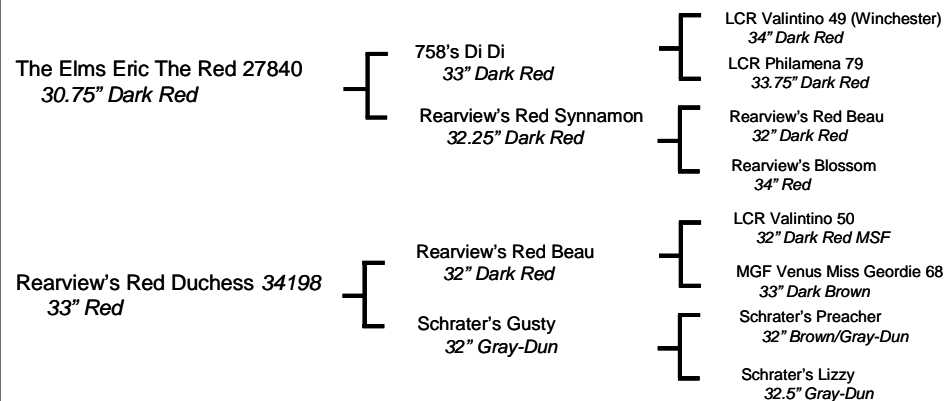

Hill's Haven Della is a beautiful, nice dark red. Her dam is Rearview's Red Duchess of the Red Beau line, and her sire is our long time herd sire, The Elms Eric the Red. She has excellent conformation, with a lot of well known dark red donkeys in her pedigree.

39 **Heiken's Ark *Sachi C***
 Light Brown/Gray-Dun Jennet, 9/19/09, Reg. #59079
 Consignor: Heiken's Ark, 30 3/8" May 11, 2011

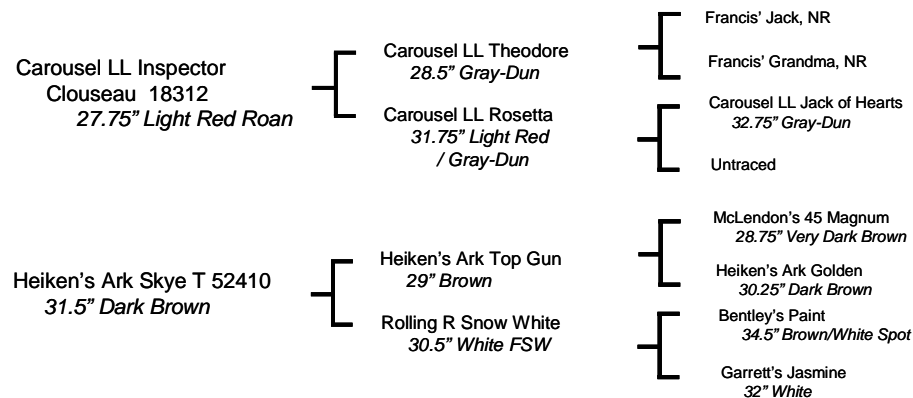

Here is a nice small, 2 year old gray jennet. She's the daughter of Inspector Clouseau, a light red 27 3/4" jack and HA Skye T a 31 1/2" dark brown daughter of HA Top Gun. Her pedigree is peppered with small donkeys. With a pedigree that includes Inspector Clouseau as her sire and 45 Magnum in the Dam's pedigree, she would be an asset for most herds.

40 Arcadian *Ellen*

Black w/Cross NLP Jennet, 5/24/09, Reg. #Pending

Consignor: Arcadian Exotics, 32" March 2011

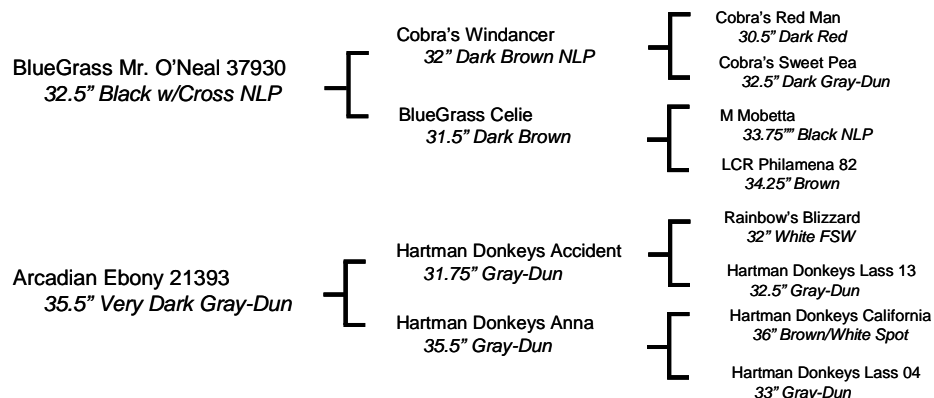

Arcadian Ellen is a black 2 year old NLP. Her sire, Mr. O'Neal traces to excellent Cobra breeding with red on the upper side of his pedigree carried by Windancer from Red Man. Mr. O'Neal's dam, Celie, is a granddaughter of Circle C Little Motown. Ellen's dam, Arcadian Ebony, has that attractive 'steely gray' color and has usually passed on her black face and muzzle. She has a full pedigree of Hartman donkeys and includes the famous 'Rainbow's Blizzard'.

41 Hill Country Miniatures *Blessing*

Dark Brown Jennet, 11/11/09, Reg. #58910

Consignor: Hill Country Miniatures, 30.25" March 2011

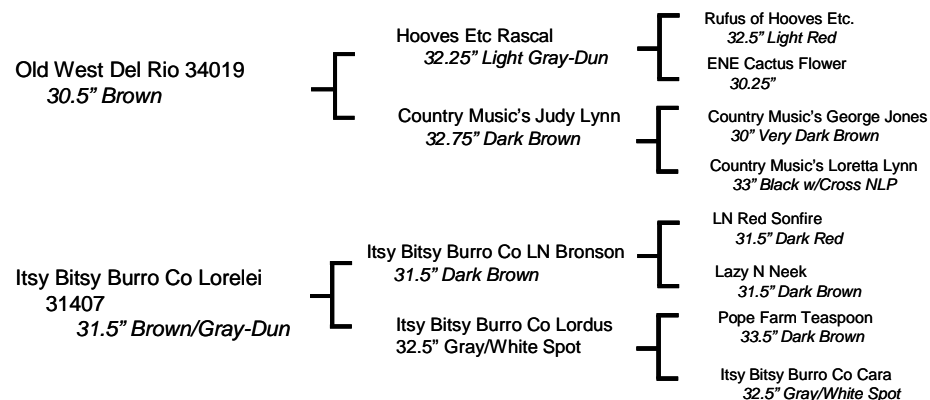

Blessing is a small, correct jennet with a deep hip, perfect top line, and a showy presence. She is the half sister of Hill Country Miniatures Poquito, the 2008 National Champion, the 2011 Reserve National Halter Champion, and the grand daughter of Bronson, another National Champion. Her sire is in Europe, so this combination will never happen again. If you want a small, very well bred jennet, here she is!

42 Country Music's *Sarah Darling*

Dark Brown Jennet, 7/10/10, Reg. #59790

Consignor: Country Music Miniature Donkeys, 21.75" at Birth

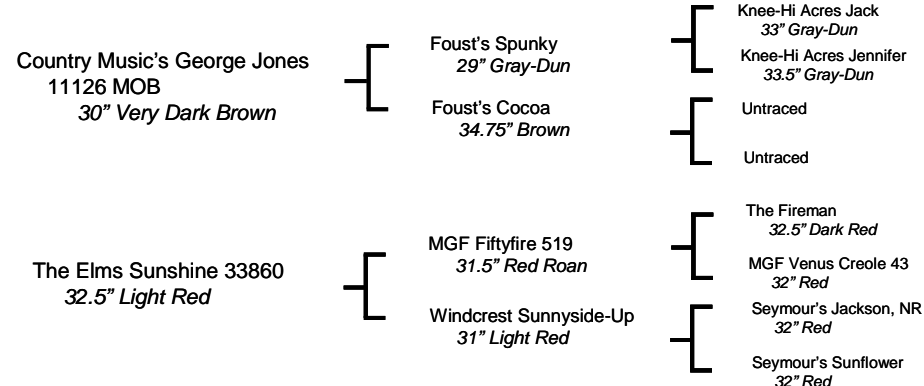

Sarah Darling has strong, sturdy conformation with very feminine appeal. She is ready to show at halter and lead line obstacle. Her dam has a 4 generation pedigree of well known, small reds, including Fiftyfire & The Fireman. Her sire, George Jones, and her grandsire, Spunky, are both National Champions at Halter. George Jones has sired over 25 National Champions at Halter and Driving in the US, Canada, Europe & New Zealand.

43 West Prairie *Angel*

Brown Jennet, 6/19/08, Reg. #56768

Consignor: West Prairie Farm, 33.5" March 2011

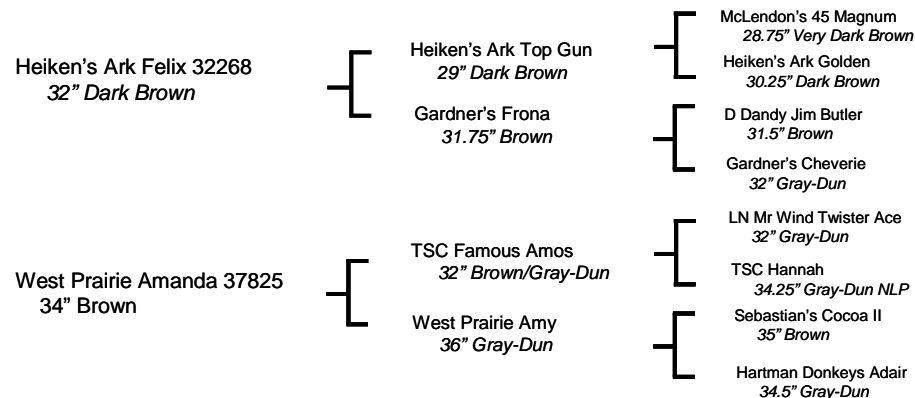

Angel has all the great features. She takes after her name. She has a full pedigree of desirable mini-donkeys on both sides. She will make a great mother. She turned 3 in March so she's ready to take home and breed to your sire. Don't let her get away!

44 Heiken's Ark *Rosabelle P*

Red Jennet, 9/3/04, 31.5" Reg. #46045

Bray'n Pool Joe with Cream

Brown Jack Foal, 5/30/11, 21.5" at Birth, Reg. #Pending

Consignor: Bray'n Pool Miniature Donkey Farm

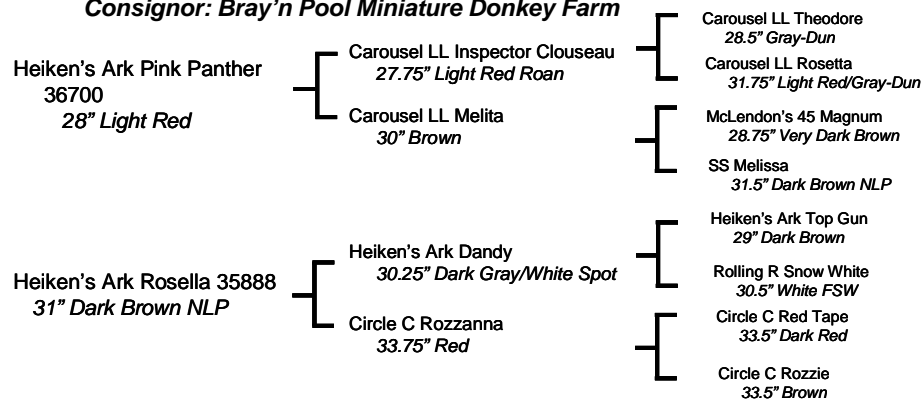

This small jennet has conformation & personality in one package. She carries Circle C blood on her Dam's side, and the great SS breeding on her Sire's side. With a great foal by her side, she's a buy not to be missed. The foal's sire is Quarter Moon High Plains Drifter, a 33.5" dark brown. Sure to be a great addition to any breeding program, this girl is ready to be the centerpiece of your herd.

45 Ass-Pirin Acres *Licorice*

Black Jennet, 5/8/10, Reg. #Pending

Consignor: Ass-Pirin Acres, 22" at Birth

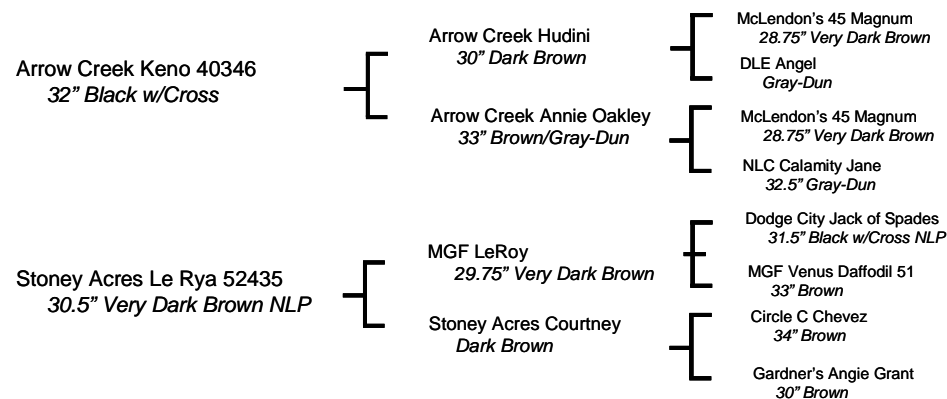

Keno always puts good bone on his foals and Licorice is no exception. She's a well built girl with style and sweetness. If you like drafty blacks, you will like this one.

46 Ravenwood *Natchez*

Dark Brown Jennet, 2/22/04, 33.25" Reg. #40395

Old Lawson Easter

Brown Jack Foal, 4/24/11, 20" at Birth, Reg. #Pending

Consignor: Old Lawson Farm

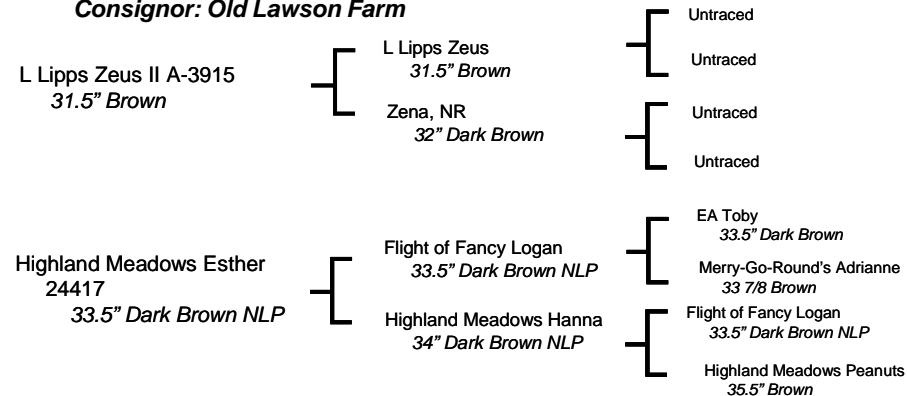

Natchez is a very nice dark brown daughter of Zeus II, out of Highland Meadows Esther. Her foal, 'Easter', is by Hill Country Miniatures Liberty. Liberty is coal black, was the 2003 Texas State Fair Grand Champion, and has also won NMDA Championships. He was used as Hill Country's herd sire for several years. Natchez sells open to breed to your jack.

47 The Elms *Preta*

Black NLP Jennet, 6/27/10, Reg. #60900

Consignor: Elms Farm Miniature Donkeys, 29.25" June 22, 2011

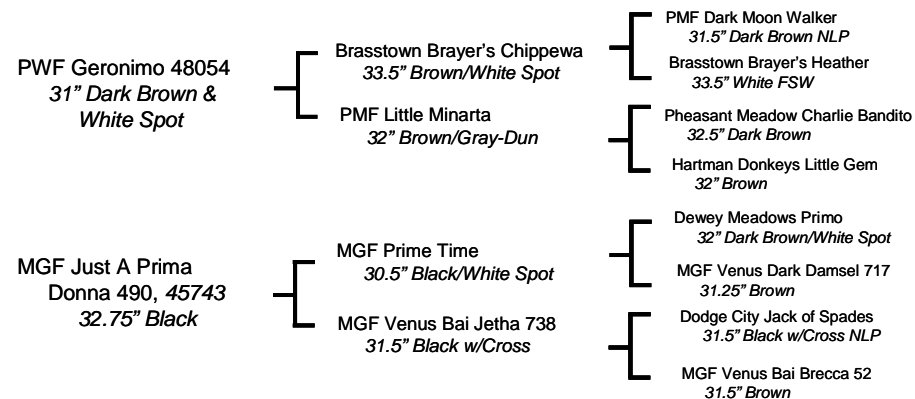

Preta means pretty, and she certainly is. She's a lovely, true black jennet with a nice full pedigree. Her sire, Geronimo, is a very bold spot and her grandsire on her dam's side, Prime Time, is known for siring smooth, well built donkeys, like Preta. She's very special in all black. You'll enjoy admiring this pretty jennet in your fields while you enhance your black and spotted programs!